

Barnicle and Husk™

MAKE YOUR VERY OWN
PAPER MAYFLOWER!

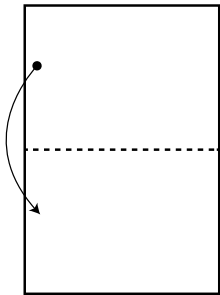

Fold piece of paper in half

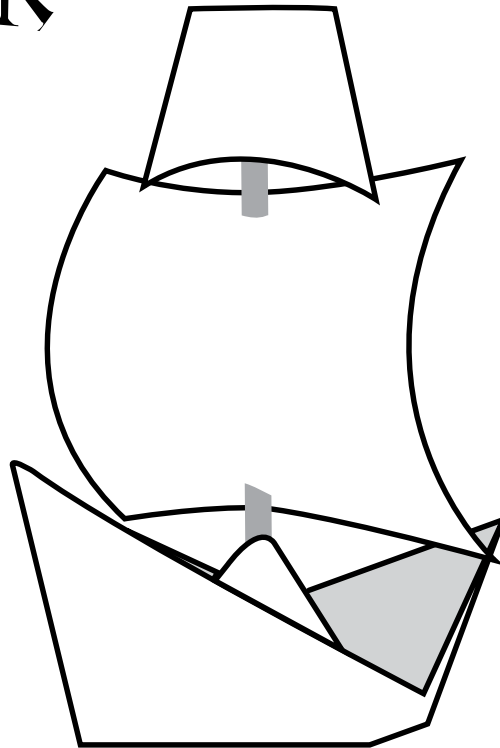
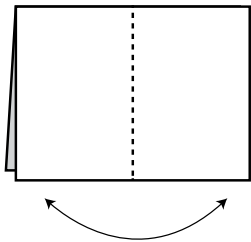

With opening facing down,
fold paper in half again,
then unfold

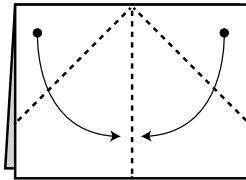

Take both top corner and
match the points in the center

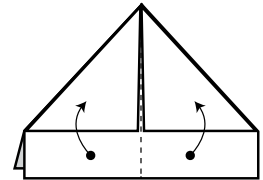

Fold bottom part upwards

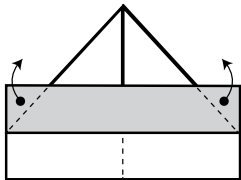

Flip over and fold corners back

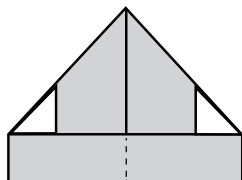

Fold remaining bottom piece up

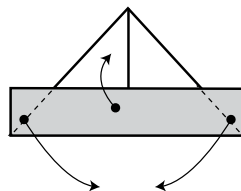

Lift the middle and push both points together

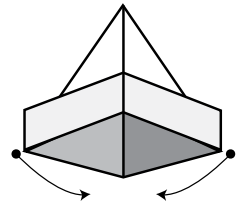

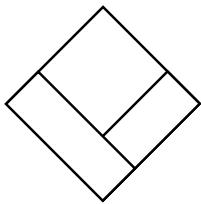
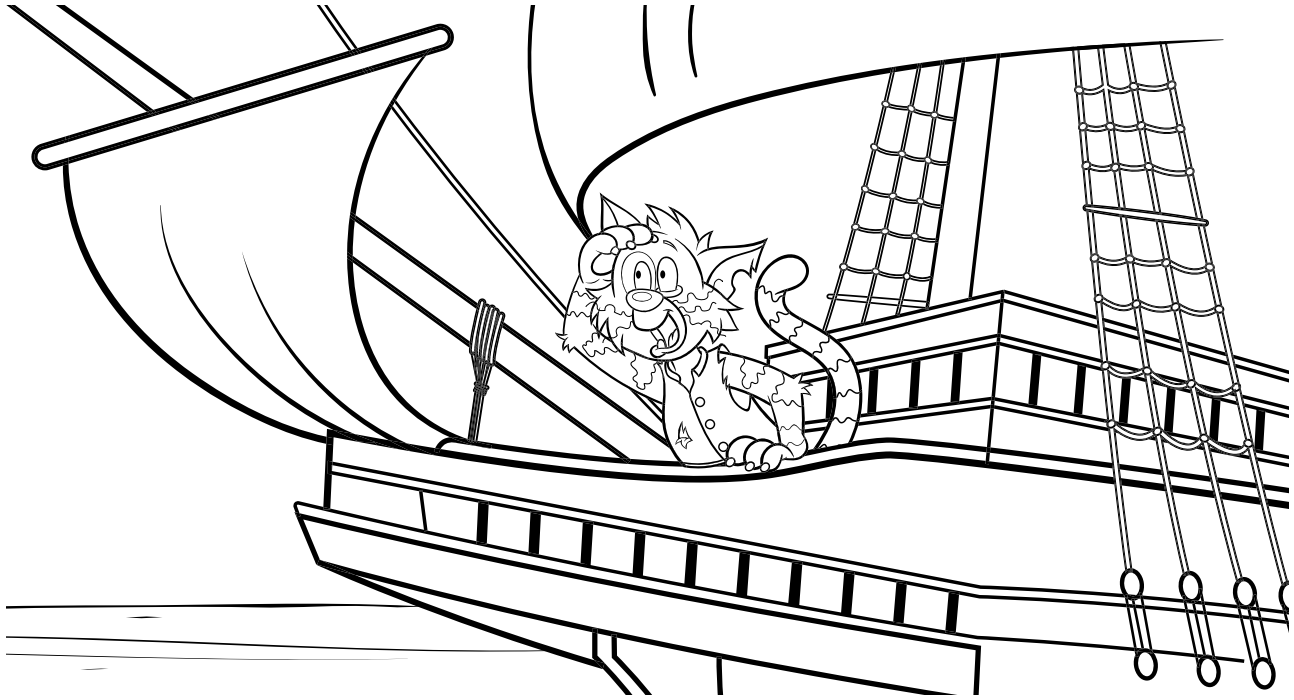

Take the new shape and fold front flap up, then turn over and fold other flap up.

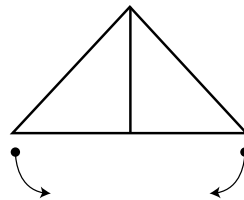
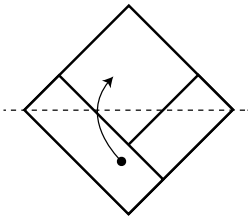

Hold bottom corners and push together

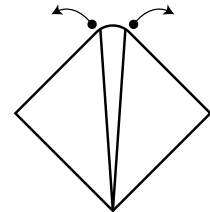

Grasp upper corners and pull apart

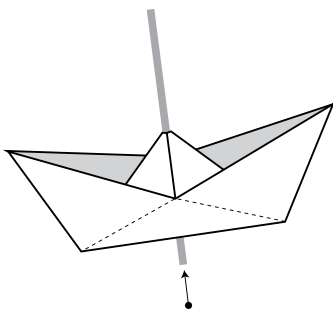

Take stick or paper clip and poke it through the bottom of the boat so it sticks out through the point.

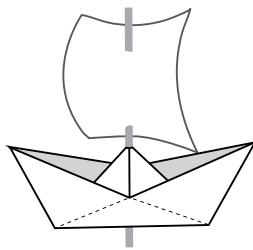

Thread the big sail onto the stick arching the sail as you do it. You can use the sail above for reference on where to poke the holes.

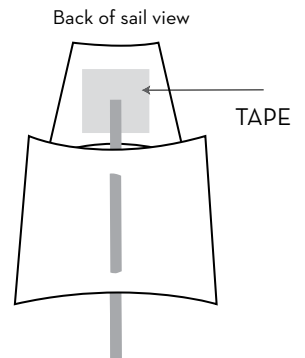
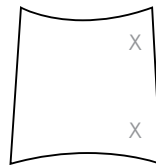

Take the small sail and use a piece of tape on the back to stick it on.

Cut off any extra stick that is extending out the bottom.

Now you are ready to sail the seven seas!